

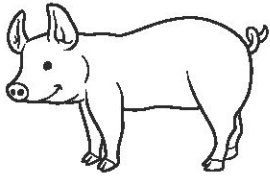

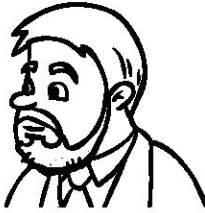

Name: _____

Listen to your teacher and think about what these pictures may have in common.

"Rain is WET. Circle or  the other pictures that are also WET."

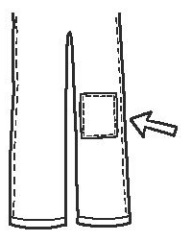

a		b	
c		d	
e		f	

"A drumstick is THIN. Circle or  the other pictures that are also THIN."

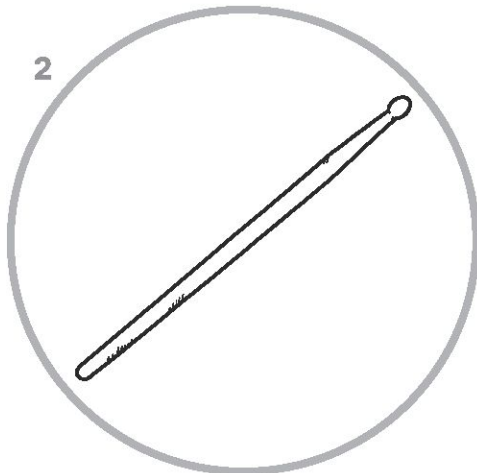

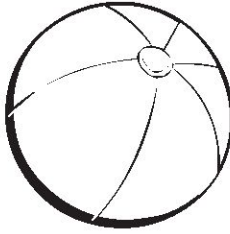
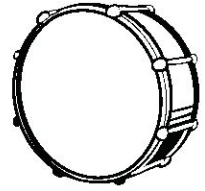
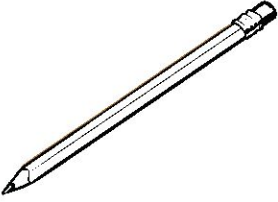
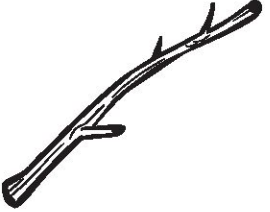
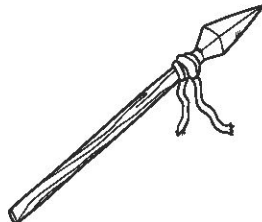
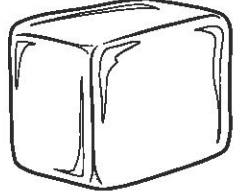
a		b	
c		d	
e		f	

★ Think of something else that is *thin*.

Name: _____



Listen to your teacher and think about what these pictures may have in common.

"A kitten is **SOFT**. Circle or  the other pictures that are also **SOFT**."

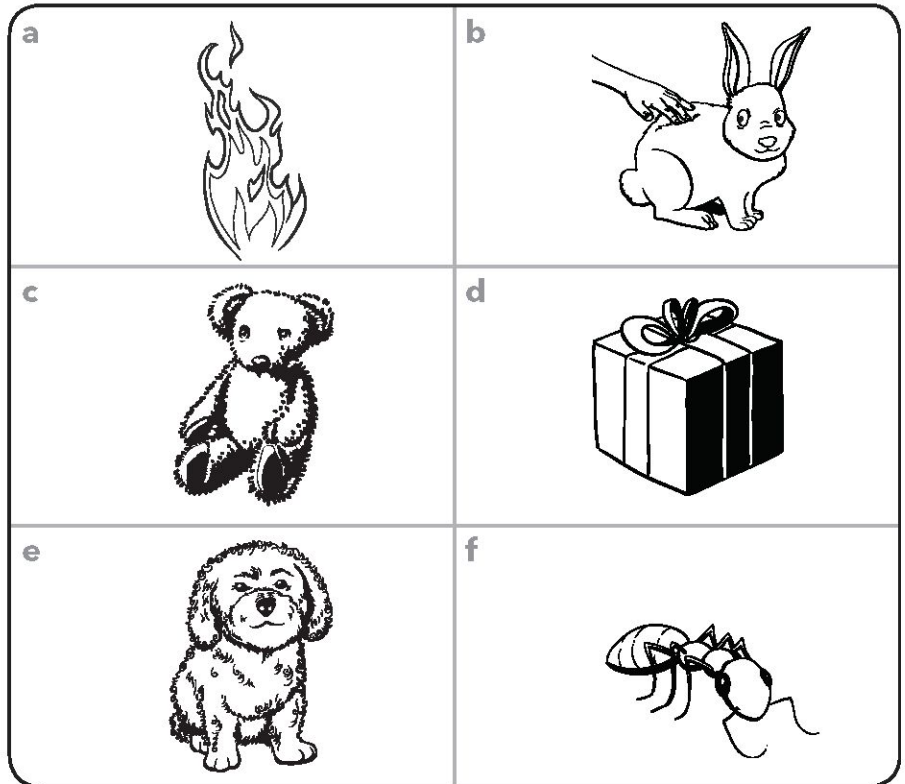

"This boy is **TIRED**. Circle or  the other pictures that are also **TIRED**."

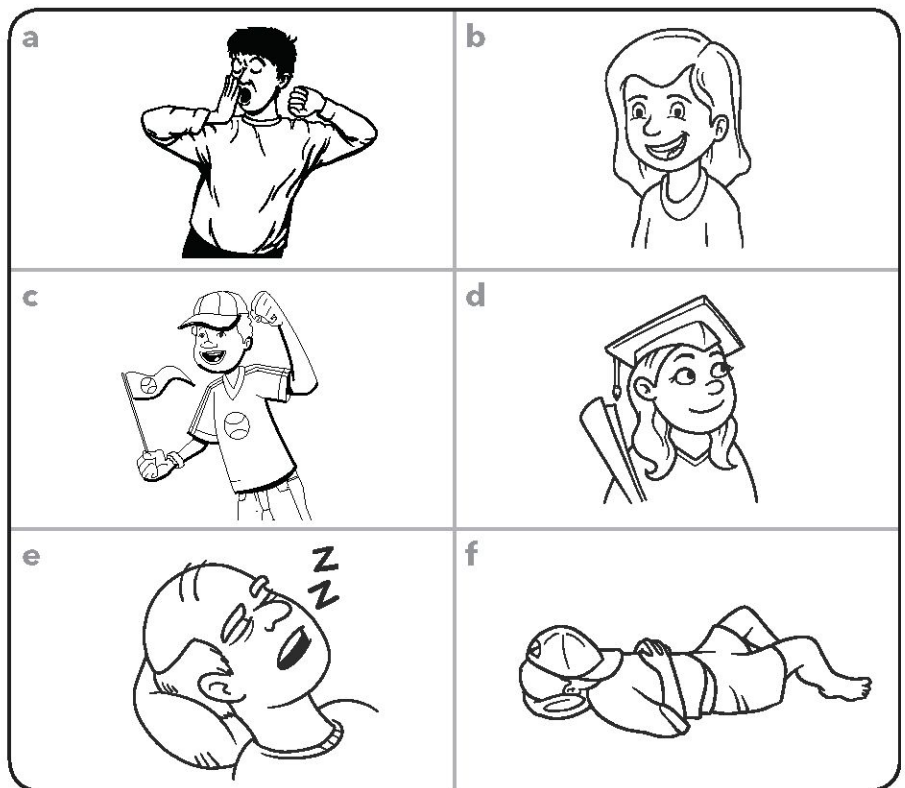

★ Think of something else that is soft.

Name: _____

Listen to the sentences. Then, cut out the pictures at the bottom of the page and glue them where they belong.

The Alvarez family is organizing the workroom.
Can you help them put their things in the right place?

Put all the things used for cleaning in the closet.

Put all the things used for writing on the desk.

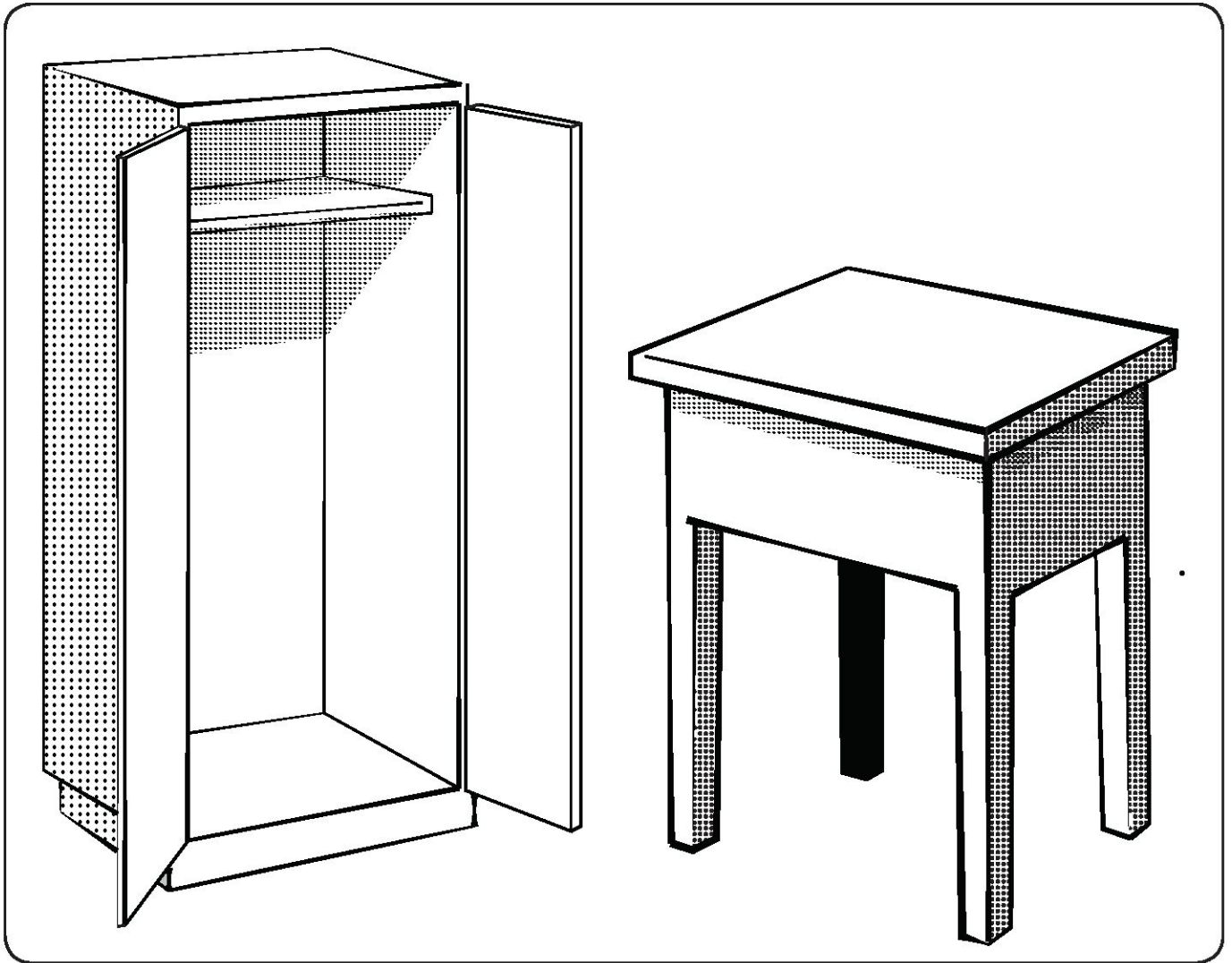

★ Explain to a partner how the things in the closet are different from the things on the desk.

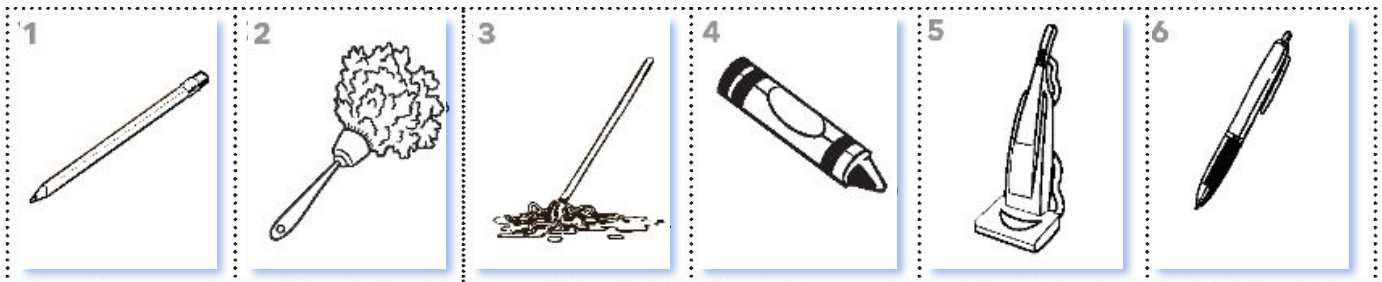

Name: _____



Circle or  the hot things red.

Circle or  the cold things blue.

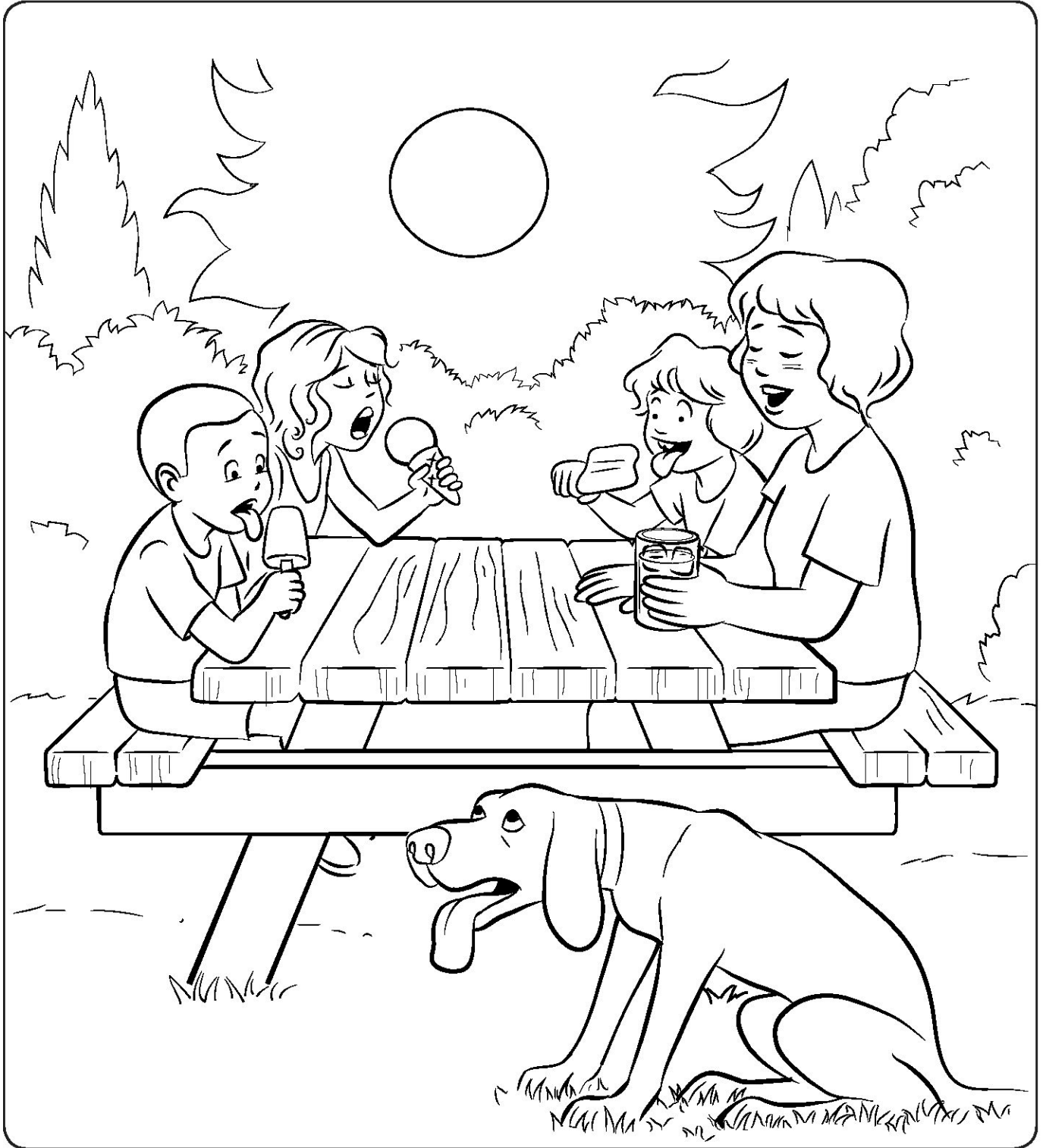

★ Explain to a partner how the red things are different from the blue things.

Name: _____



Circle or  the three pictures that begin with the same sound as the picture in the circle.

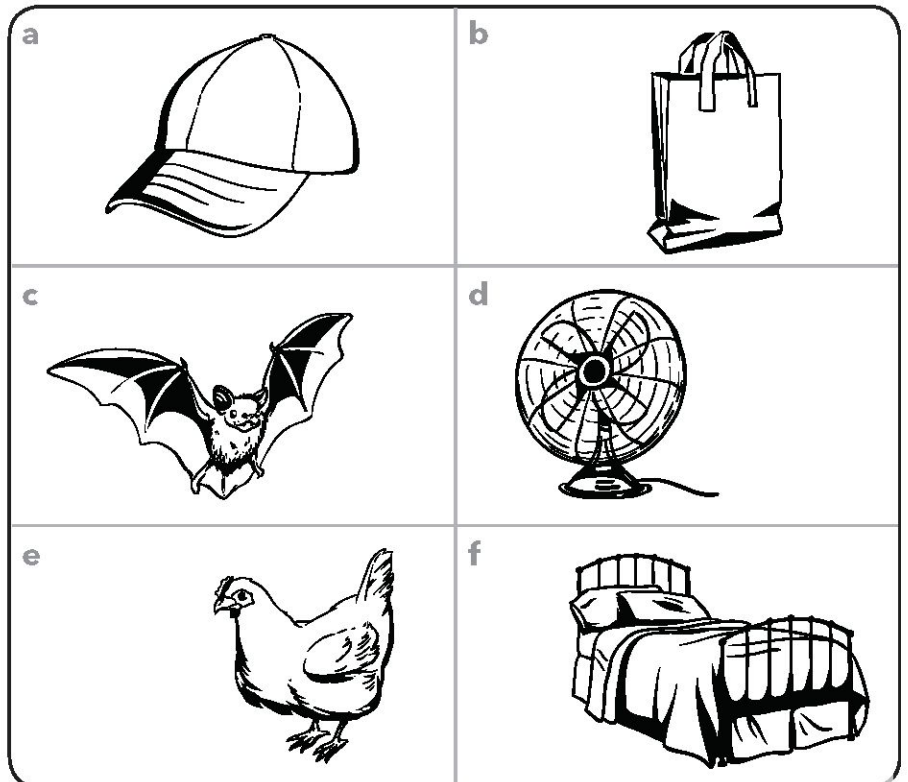
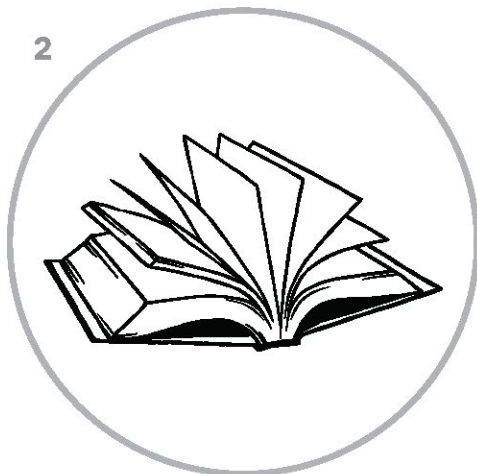
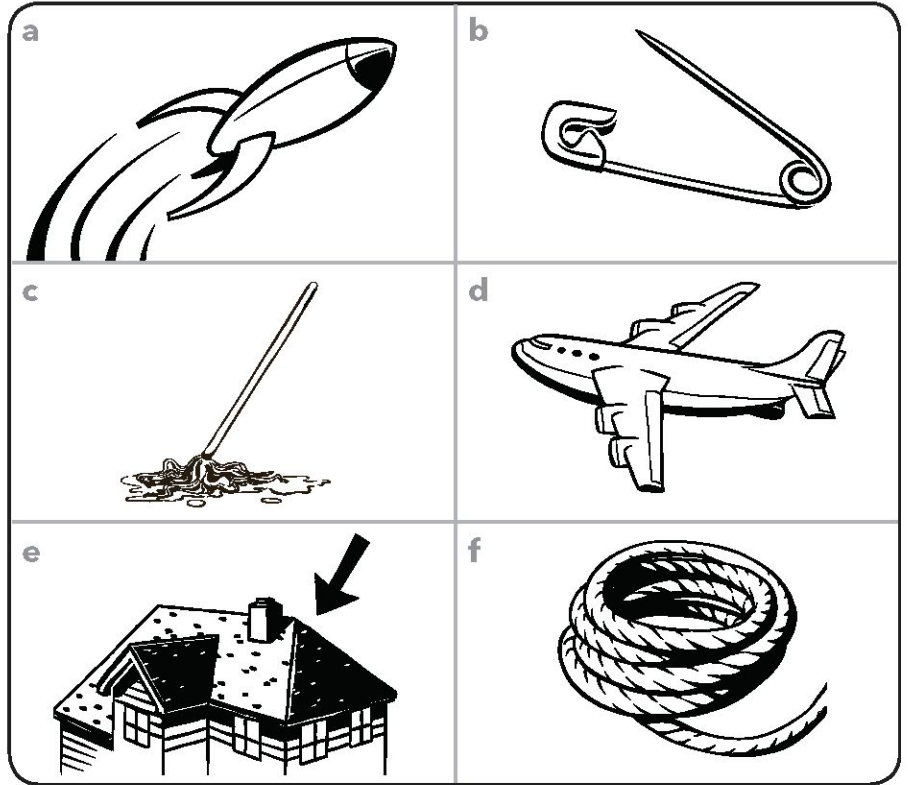

1. RAIN: a. rocket, b. pin, c. mop, d. airplane, e. roof, f. rope; 2. BOOK: a. cap, b. bag, c. bat, d. fan, e. hen, f. bed

★ For each circled picture, think of another word that begins with the same sound.

Name: _____



Circle or  the three pictures that begin with the same sound as the picture in the circle.

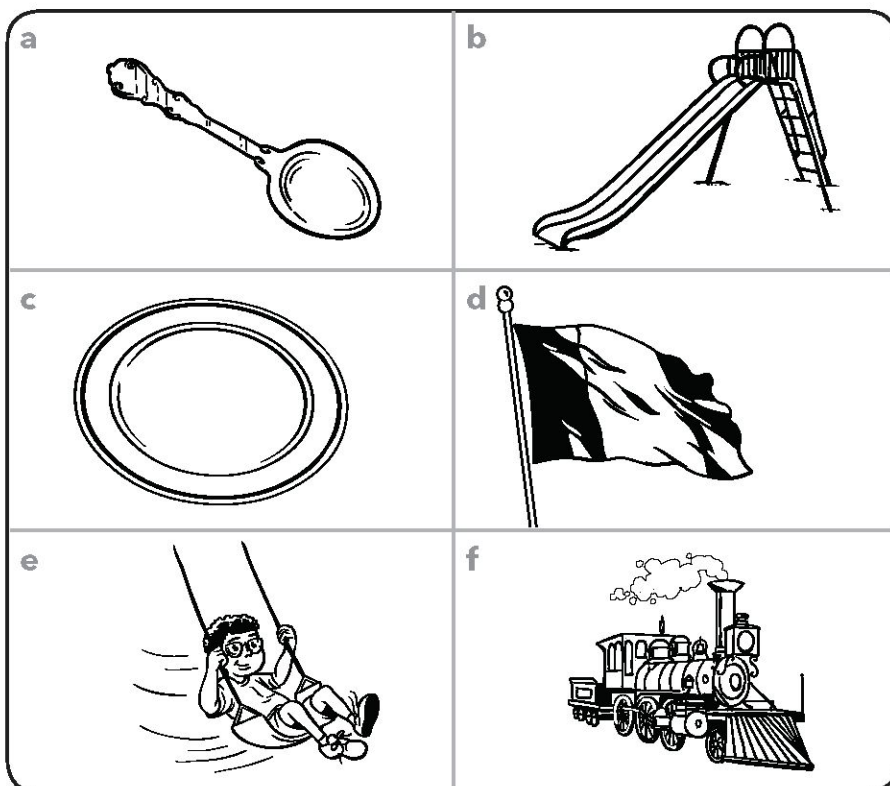
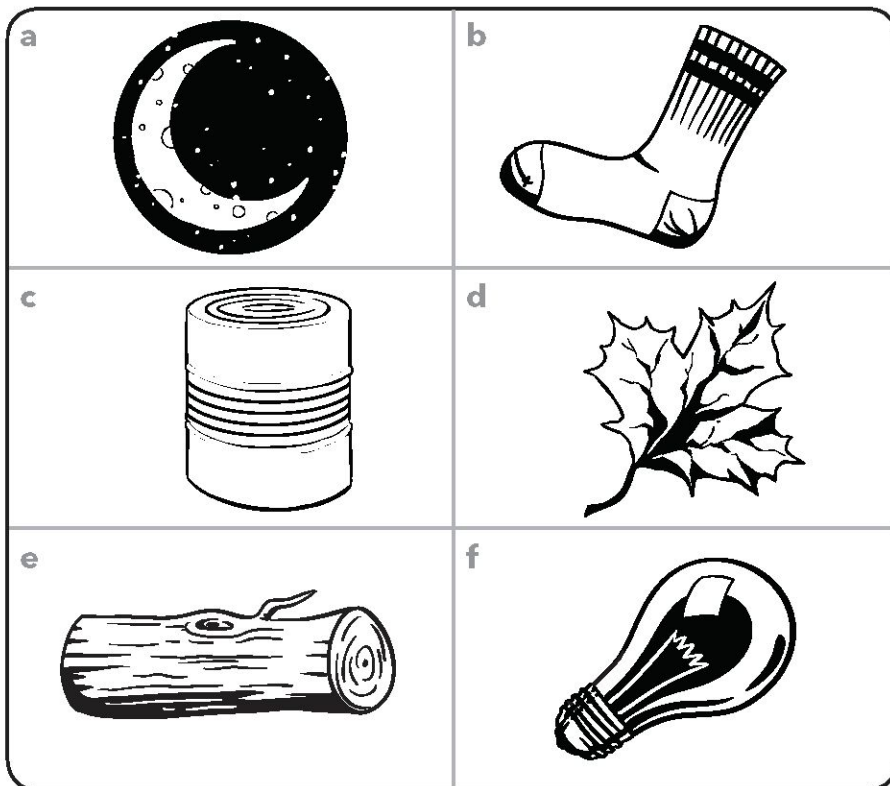









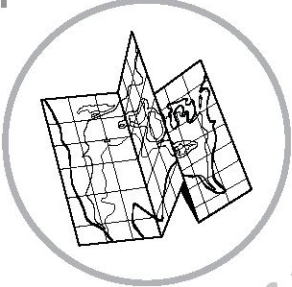

1. LOCK: a. moon, b. sock, c. can, d. leaf, e. log, f. light; 2. SNAIL: a. spoon, b. slide, c. plate, d. flag, e. swing, f. train

★ For each circled picture, think of another word that begins with the same sound.

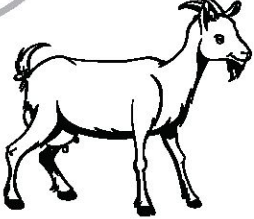
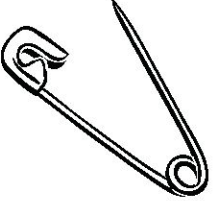
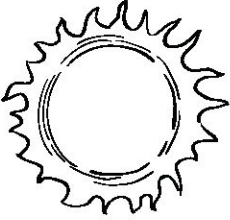
Name: _____

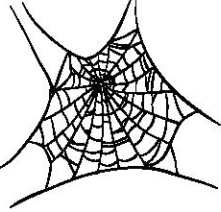
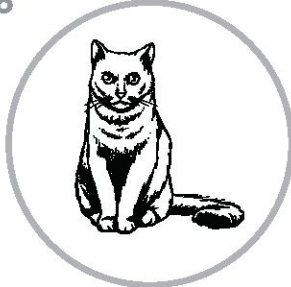
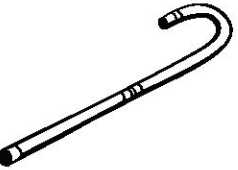

Circle the one picture in each box that begins with the same sound as the picture that is already circled.

<p>1</p>   	<p>2</p>   
<p>3</p>   	<p>4</p>   
<p>5</p>   	<p>6</p>   

1. map, sock, mouse; 2. nine, nose, goat; 3. hat, hand, pin; 4. doll, sun, dog; 5. wig, van, web; 6. cat, cane, dice

★ For each picture you circled, think of another word that begins with the same sound.

Name: _____



Circle the one picture in each box that begins with the same sound as the picture that is already circled.

<p>1</p> <p>The frog is circled with a dashed line.</p>	<p>2</p> <p>The snail is circled with a solid line.</p>
<p>3</p> <p>The grapes are circled with a solid line.</p>	<p>4</p> <p>The bread is circled with a solid line. An arrow points to the fire.</p>
<p>5</p> <p>The clock is circled with a solid line.</p>	<p>6</p> <p>The sled is circled with a solid line.</p>

1. flag, frog, truck; 2. snail, train, slide; 3. grapes, spoon, glove; 4. bread, block, smoke; 5. clock, plane, crayon; 6. sled, crown, swing

★ For each picture you circled, think of another word that begins with the same sound.

Name: _____



Cut out the pictures at the bottom of the page. Find all the pictures that begin with the same sound as the pictures in the circles. Then, glue them into the correct box.

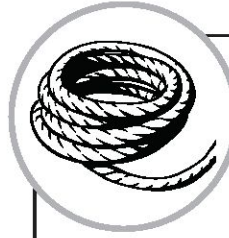
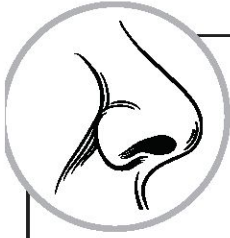

Empty rectangular box for pasting pictures that begin with the same sound as the nose.

Empty rectangular box for pasting pictures that begin with the same sound as the rope.

NOSE, ROPE; 1. nail, 2. rainbow, 3. net, 4. rock, 5. nine, 6. ring

★ Think of another word that begins with the same sound as the words in each box.

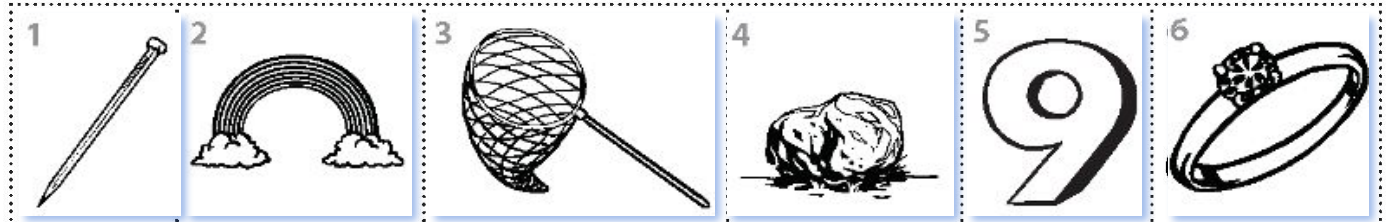

Name: _____



Cut out the pictures at the bottom of the page. Find all the pictures that begin with the same as the pictures in the circles. Then, glue them into the correct box.

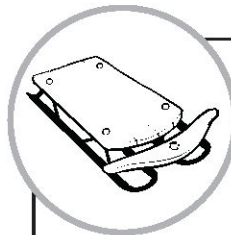
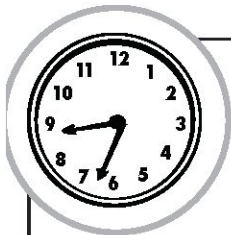

CLOCK, SLED; 1. star, 2. crown, 3. spoon, 4. crab, 5. swing, 6. cloud

★ Think of another word that begins with the same sound as the words in each box.



Name: _____



Cut out the pictures at the bottom of the page and count the *syllables* in each word. Then, glue each picture onto the correct number.

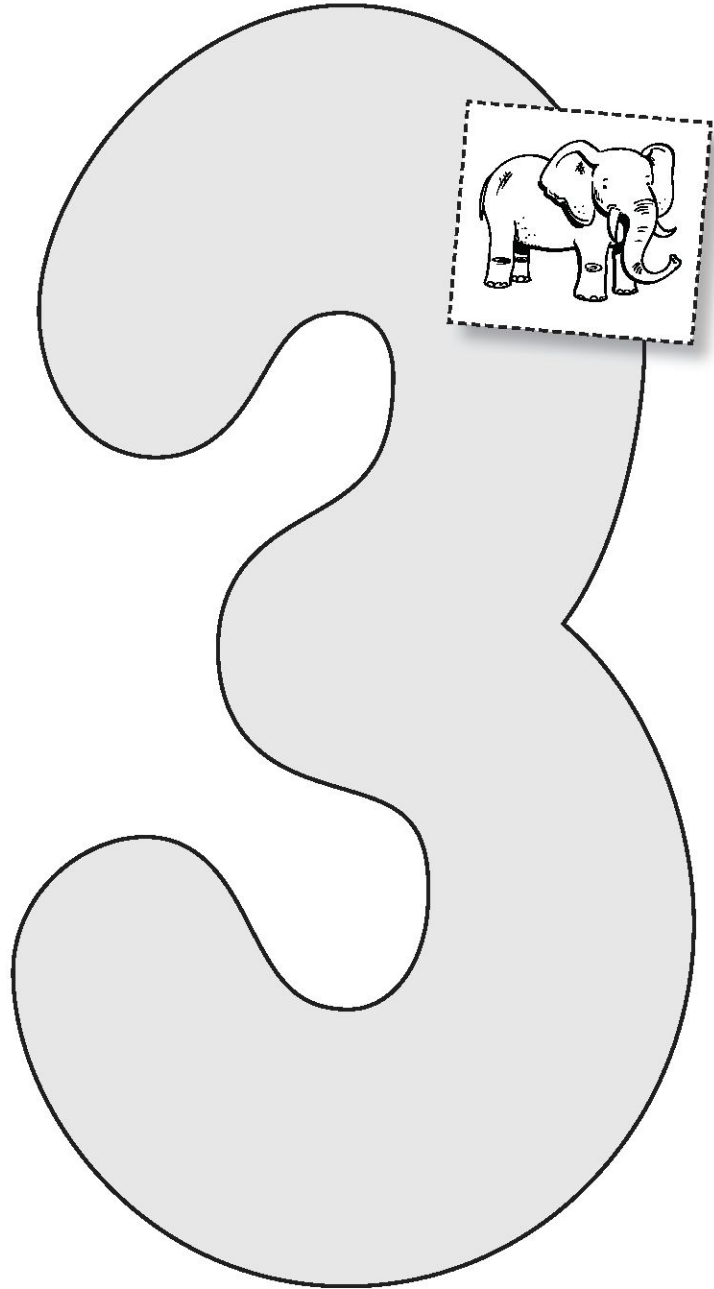
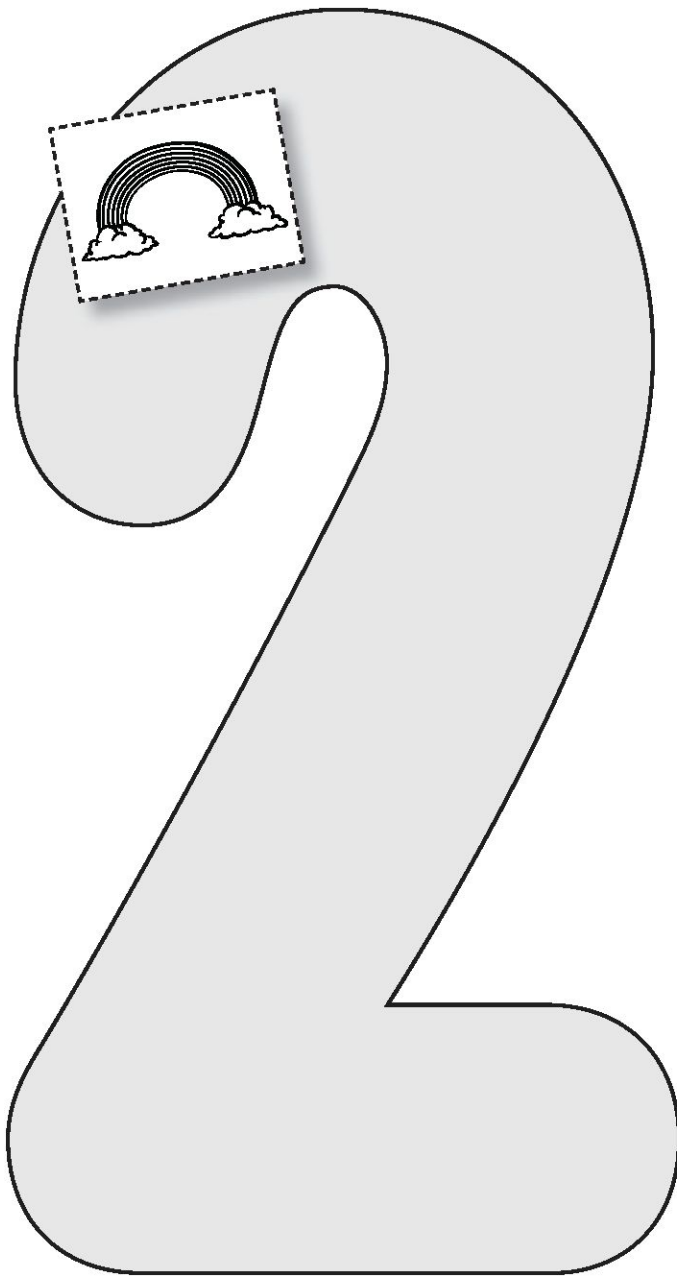

RAINBOW, ELEPHANT; 1. umbrella, 2. hamburger, 3. apple, 4. gumball, 5. banana, 6. candle

★ Count the syllables in your name. Write the number at the top of the page.

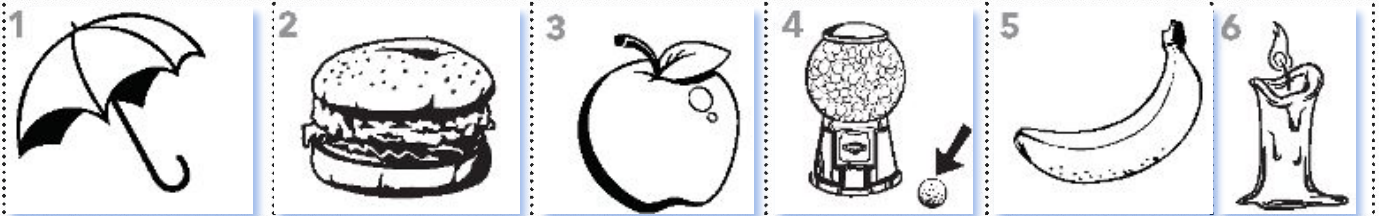

Name: _____



Look at each row and say the words in the first box. Blend the two words together to make a new word. Circle or  the picture of the new word.

1

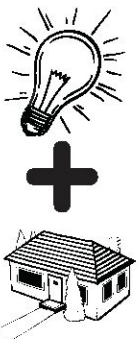

+

=

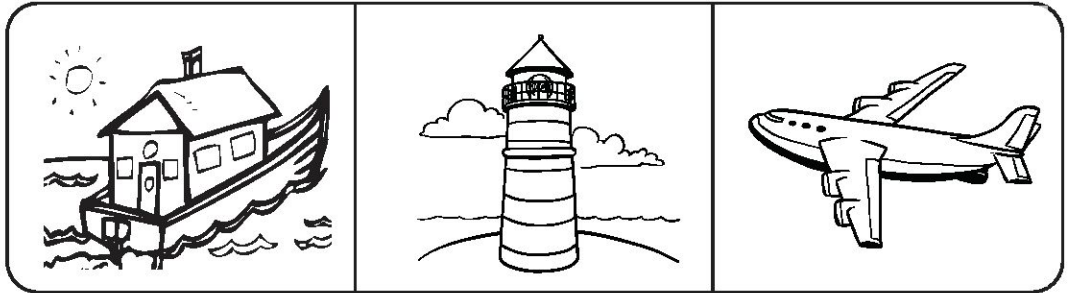

2

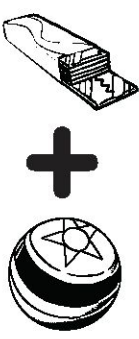

+

=

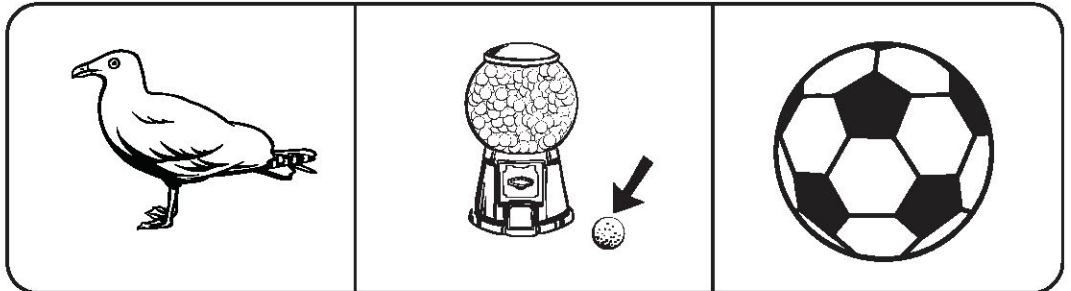

3



+

=

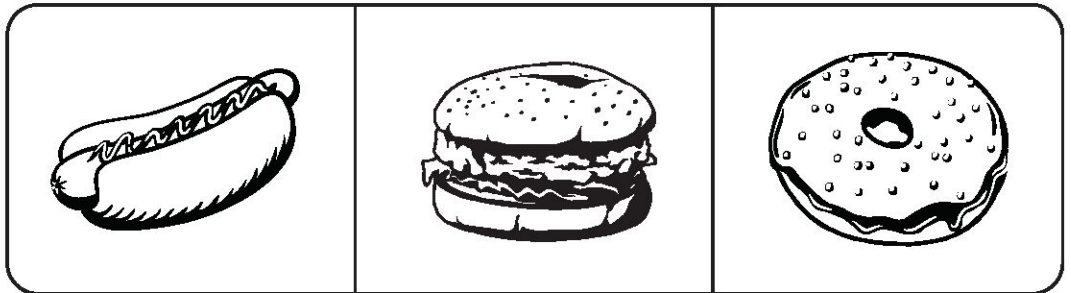

4



+

=



1. light + house, houseboat, lighthouse, airplane; 2. gum + ball, seagull, gumball, soccer ball; 3. hot + dog, hotdog, hamburger, doughnut; 4. pan + cake, teacup, cupcake, pancake

★ Name the pictures you did not 

Name: _____



Look at the picture in each circle. Say the word in parts. Circle the pictures of the small words that you hear.

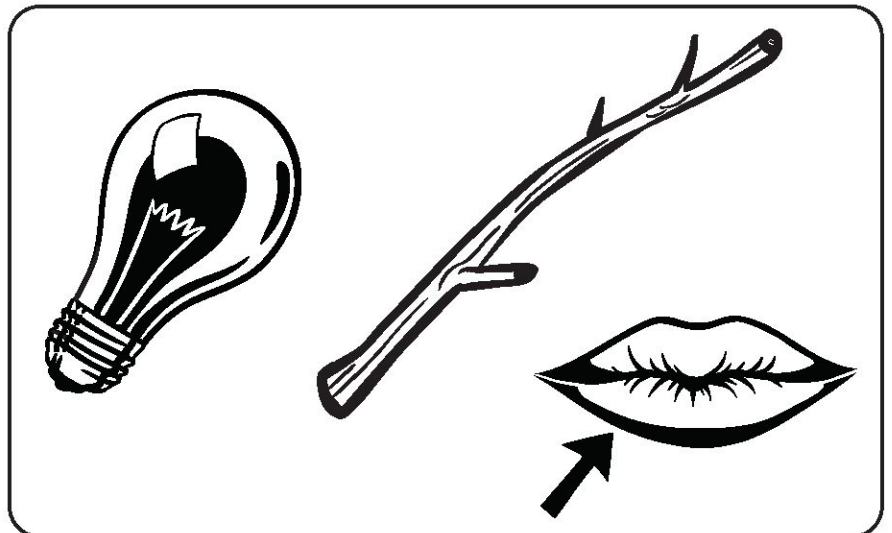
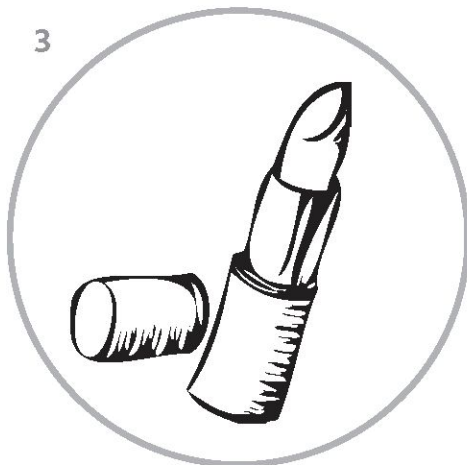
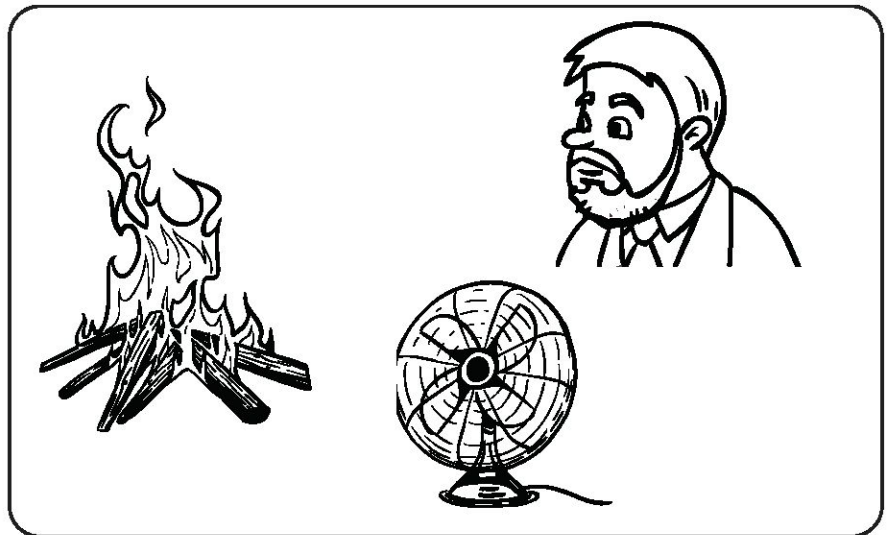
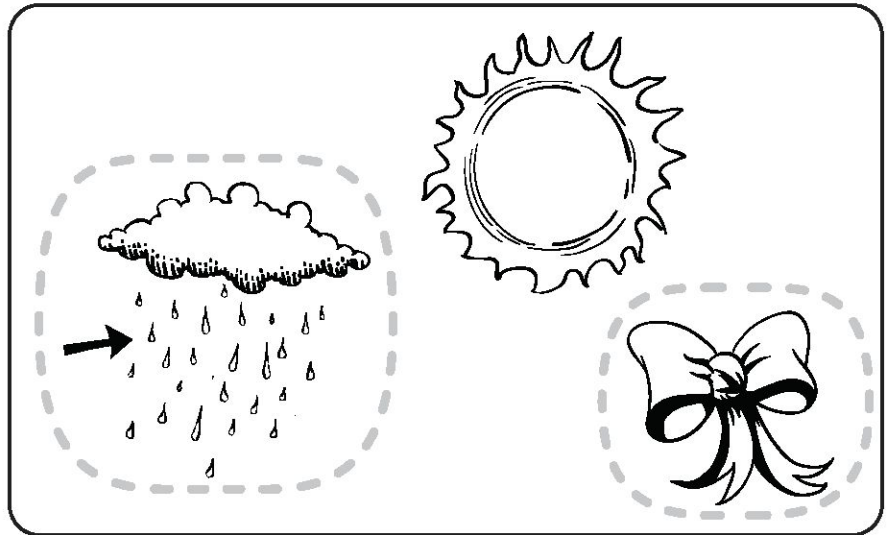
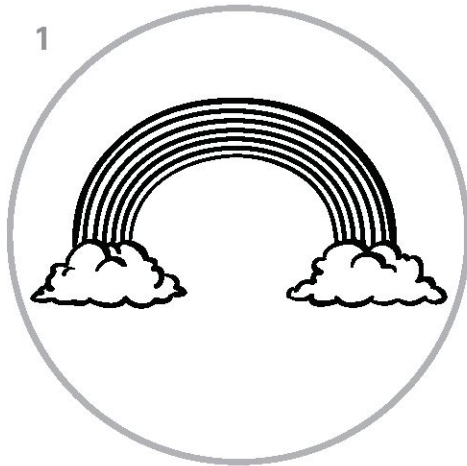

1. RAINBOW: rain, sun, bow; 2. FIREMAN: fire, fan, man; 3. LIPSTICK: light, stick, lip

★ Count the number of syllables in each circled word. Write the number in the circle.

Name: _____



Look at the picture in each circle. Say the word in parts. Circle the pictures of the small words that you hear.

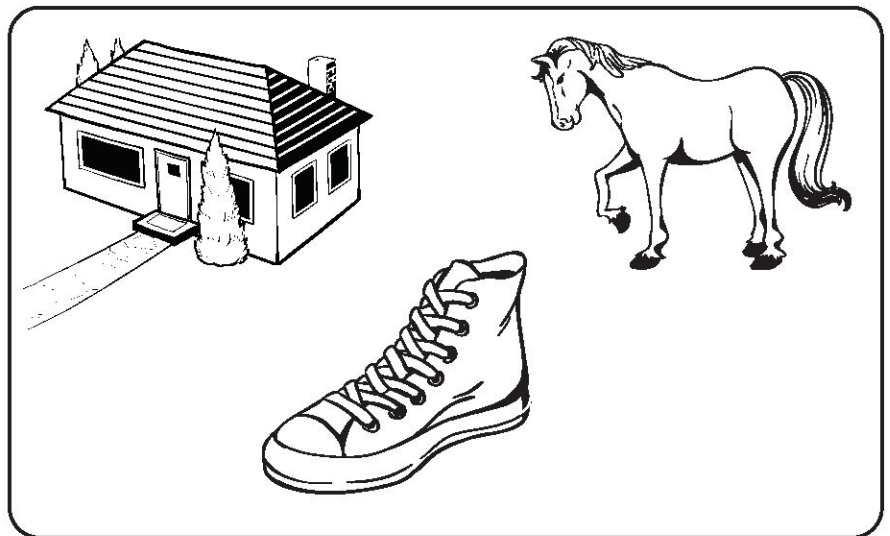
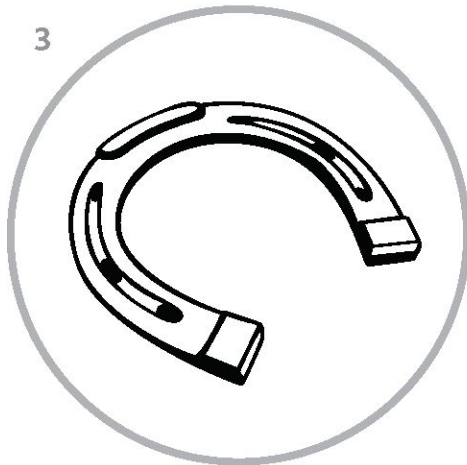
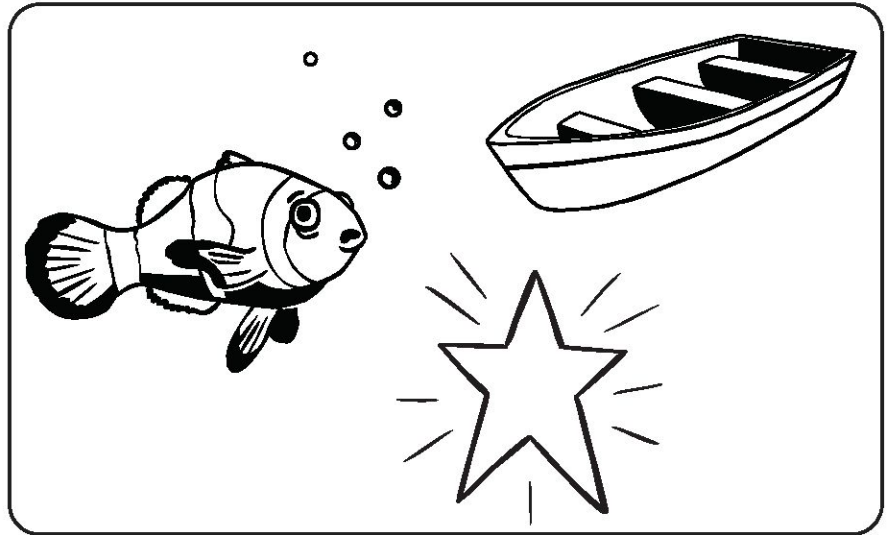
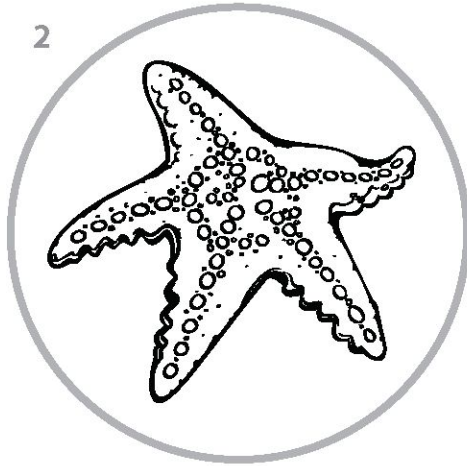
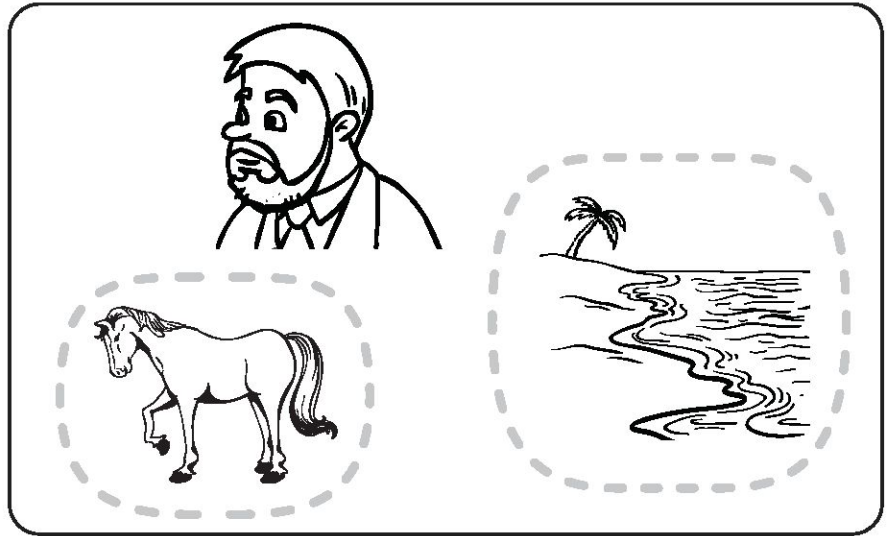
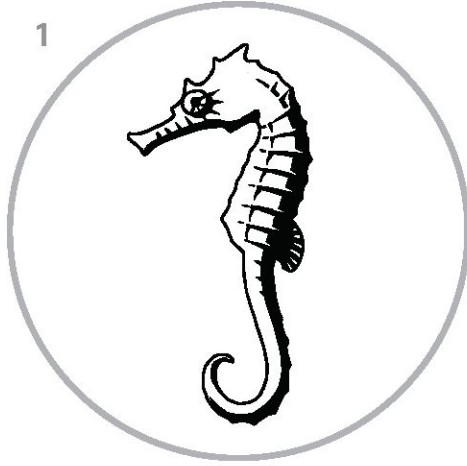



1. SEAHORSE: man, horse, sea; 2. STARFISH: fish, star, boat; 3. HORSESHOE: house, shoe, horse

★ Count the number of syllables in each circled word. Write the number in the circle.

Name: _____

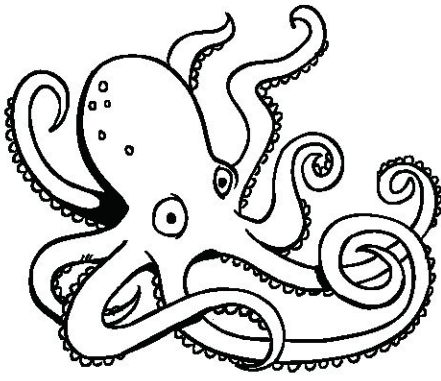
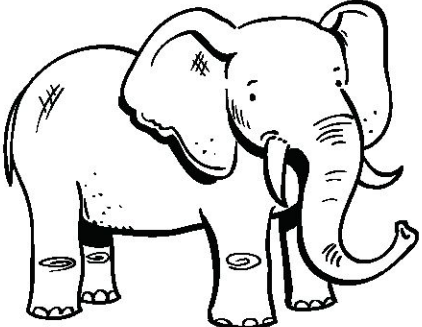

Look at each picture and say the word one syllable at a time. Circle the number of syllables you hear.

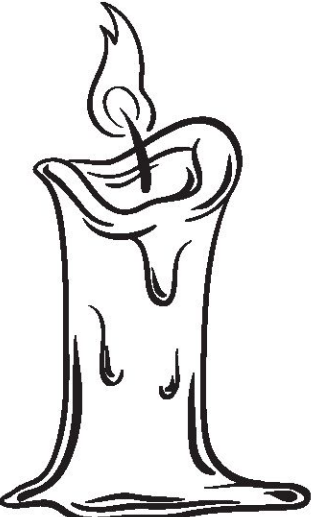
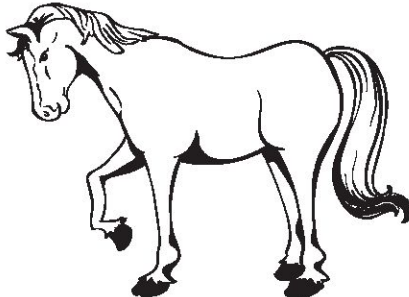
<p>1</p>  <p>1 2 3</p>	<p>2</p>  <p>1 2 3</p>
<p>3</p>  <p>1 2 3</p>	<p>4</p>  <p>1 2 3</p>
<p>5</p>  <p>1 2 3</p>	<p>6</p>  <p>1 2 3</p>



1. pumpkin, 2. octopus, 3. elephant, 4. scissors, 5. candle, 6. horse

★ For each picture, take turns with a partner saying one syllable at a time.

Name: _____

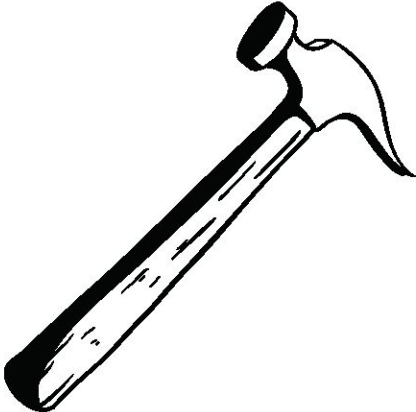

Look at each picture and say the word one syllable at a time. Circle the number of syllables you hear.

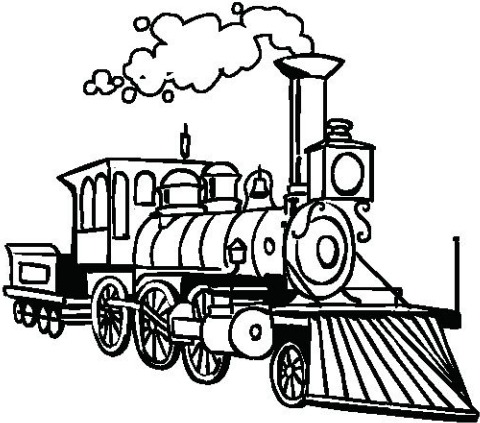
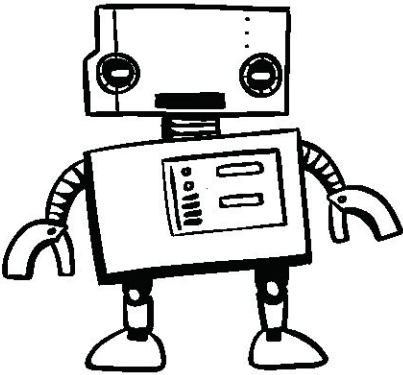
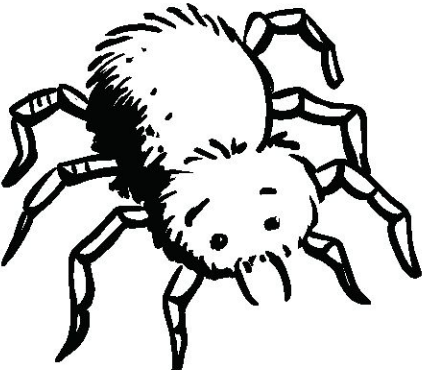
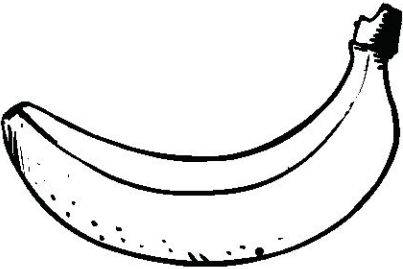
<p>1</p>  <p>1 2 3</p>	<p>2</p>  <p>1 2 3</p>
<p>3</p>  <p>1 2 3</p>	<p>4</p>  <p>1 2 3</p>
<p>5</p>  <p>1 2 3</p>	<p>6</p>  <p>1 2 3</p>

1. hammer, 2. umbrella, 3. train, 4. robot, 5. spider, 6. banana

★ For each picture, take turns with a partner saying one syllable at a time.

Name: _____



Letters in the alphabet always go in the same order. Look at the letters in each box. Fill in the missing letter.

1 A C

2 Q S

3 T V

4 D F

5 H J

6 W Y

7 S U

8 M O

9 K M

10 C E

11 N P

12 X Z

★ Practice saying the name of each letter with a partner.

Name: _____



Letters in the alphabet always go in the same order. Look at the letters in each box. Fill in the missing letter.

1

a c

2

p r

3

x z

4

i k

5

c e

6

l n

7

v x

8

f h

9

s u

10

b d

11

m o

12

r t

★ Practice saying the name of each letter with a partner.

Name: _____



Letters in the alphabet always go in the same order. Look at the letters in each box. Fill in the missing letter.

1 B C

2 I J

3 X Z

4 Q R

5 L M

6 D F

7 S T

8 P Q

9 K L

10 U V

11 N O

12 E G

★ Practice saying the name of each letter with a partner.

Name: _____



Letters in the alphabet always go in the same order. Look at the letters in each box. Fill in the missing letter.

1 m n

2 c d

3 w y

4 j k

5 f g

6 t u

7 o p

8 d e

9 v x

10 i j

11 q r

12 u w

★ Practice saying the name of each letter with a partner.

Name: _____



Each sentence begins with a capital letter and ends with a period (full stop). Put your finger on the capital letter at the beginning and follow along as you listen. Then, answer the questions below.

Pia Piglet

1

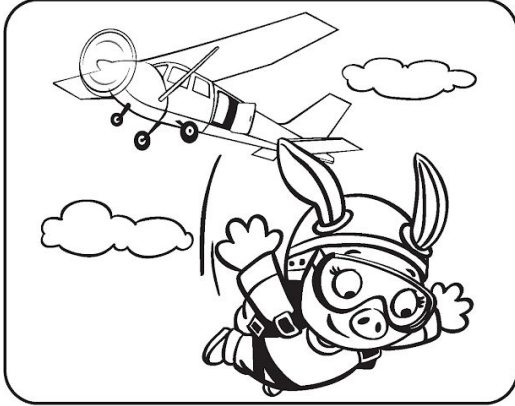

Pia Piglet jumped out of the plane.

2

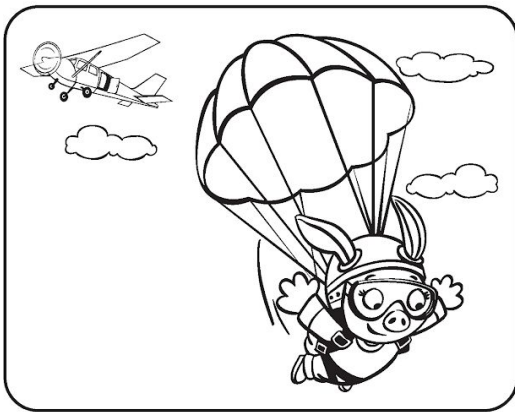

Pia's pink parachute opened up.

3

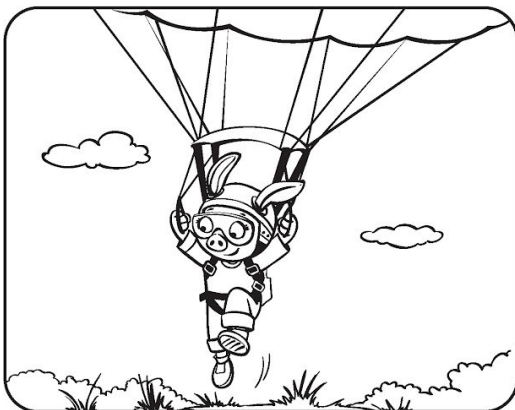

Pia Piglet landed safely on the grass.

- What happened in the story? Retell this story using the pictures to help you remember the important details.
- What part did you like the most? Circle the picture that shows the best part.

★ Listen and look for the spaces between words as an adult reads the story again. Jump or clap for each word you hear.

Name: _____



Each sentence begins with a capital letter and ends with a period (full stop). Put your finger on the capital letter at the beginning and follow along as you listen. Then, answer the questions below.

Carlos the Cat

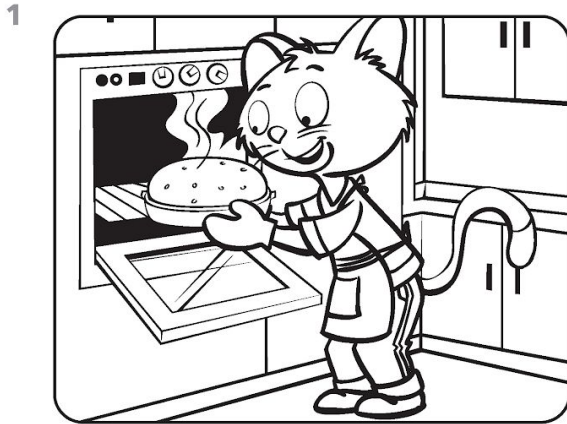

Carlos the cat baked a cake.



Carlos put the cake in a big box.

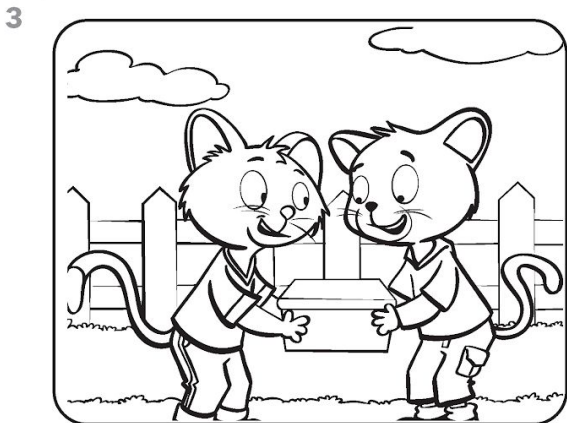

Carlos the cat gave the cake to his friend.

- What happened in the story? Retell this story using the pictures to help you remember the important details.
- What part did you like the most? Circle the picture that shows the best part.

★ Listen and look for the spaces between words as an adult reads the story again. Jump or clap for each word you hear.



Each sentence begins with a capital letter and ends with a period (full stop). Put your finger on the capital letter at the beginning and follow along as you listen. Then, answer the questions below.

Manny the Mouse

1



Manny the mouse opened a tub of ice cream.

2

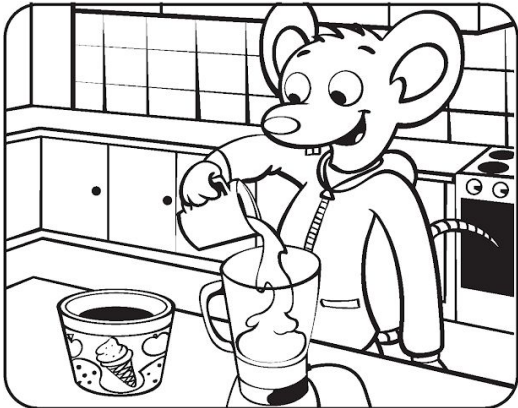

Manny mixed the ice cream with a cup of milk.

3



Manny the mouse enjoyed the yummy milkshake he made.

- What happened in the story? Retell this story using the pictures to help you remember the important details.
- What part did you like the most? Circle the picture that shows the best part.

★ Listen and look for the spaces between words as an adult reads the story again. Jump or clap for each word you hear.